

ENMET Corporation
PO Box 979
Ann Arbor, MI 48106-0979

ISA-200 RAL
ISA-200 RAL O
Operation and Maintenance
Manual

80002-039
07/14/00
MCN-237, 09/20/00
MCN-274, 04/12/02

Table of Contents

1.0 INTRODUCTION	1
1.1 Unpack.....	1
1.2 Check Order.....	1
1.3 Serial Numbers	1
2.0 INSTRUMENT FEATURES	2
2.1 Exterior Features	2
2.2 Display Panel Features	2
2.3 Circuit Board Features	4
2.3 Power Supply	4
3.0 INSTALLATION	5
3.1 Mounting of Instrument	5
3.2 Sample Air Supply	6
3.3 Power Supply	6
3.4 Outputs	6
3.4.1 Relay Contacts	6
3.4.2 Optional 4-20mA Outputs	7
3.5 Initial Calibration	7
4.0 OPERATION	8
4.1 Normal Operation Condition.....	8
4.2 Alarm Set Points	8
4.3 Alarm Latching.....	8
4.4 Audio Defeat.....	9
4.5 Display	9
4.6 Operational Menu.....	9
4.7 Fault Indications.....	9
4.7.1 Low Flow Indication.....	9
4.7.2 Other Fault Indications.....	9
5.0 MAINTENANCE	10
5.1 Maintenance Menu	10
5.1.1 Key.....	11
5.1.2 Automatic Zeroing	12
5.1.3 Calibration.....	13
5.1.4 Select Alarm Set Points.....	14
5.1.5 Set Latches.....	15
5.1.6 Set the Key	15
5.1.7 Exit	15
5.2 Sensor Replacement.....	16
5.2.1 CO Sensor.....	16
5.2.2 Oxygen Sensor.....	16
5.3 Humidifier Tube.....	16
5.4 Flow Control Orifice.....	16
5.5 Particulate Filter Replacement.....	16
6.0 REPLACEMENT PART NUMBERS	18
7.0 WARRANTY	19
APPENDIX A	20

List of Illustrations

FIGURE 1: FEATURES OF ISA-200 RAL(O) EXTERNAL	3
FIGURE 1A: REGULATOR.....	3
FIGURE 2: ISA-200 RAL(O) INTERIOR FEATURES.....	4
FIGURE 3: ISA-200 RAL(O) MOUNTING DIMENSIONS	5
TABLE 1: RELAY CONTACTS.....	6
TABLE 2: FAULT RELAY CONTACTS.....	7
TABLE 3: OUTPUTS FOR 4-20MA	7
FIGURE 4: ISA-200 RAL(O) OPERATIONAL DISPLAY	8
TABLE 4: FACTORY ALARM SET POINTS.....	8
FIGURE 5: ISA-200 RAL(O) OPERATION MENU FLOW CHART	9
FIGURE 6: ISA-200 RAL(O) MAINTENANCE MENU FLOW CHART	10
FIGURE 7: CONNECTION OF CALIBRATION GAS CYLINDER	12
TABLE 5: FAULT ALARM	14
FIGURE 8: REMOVE SHORTING CLIP	17
FIGURE 9: MANIFOLD.....	17
FIGURE 10: LOCATION OF PARTS FOR REPLACEMENT	17
FIGURE 11: CARBON MONOXIDE CONCENTRATION.....	20

NOTE: [important information about use of instrument]

CAUTION: [affects equipment – if not followed may cause damage to instrument, sensor etc...]

WARNING: [affects personnel safety – if not followed may cause bodily injury or death.]

1.0 Introduction

The **ISA-200 RAL(O)** is an instrument that monitors compressed air supply systems for certain hazards to the user. The instrument is available with sensors that monitor air for carbon monoxide (CO), for variations in the oxygen (O₂) content. The sensors can be used alone or both used together. In the instrument, a sample of the compressed air is passed over electrochemical CO and O₂ sensors, the resultant electrical outputs are used to evaluate the air for the target gases. Some features of the instruments are as follows:

- continuous monitoring of the sample air
- continuous LCD display of gas and vapor concentrations
- menu driven operational and maintenance controls
- menu driven calibration procedure
- audio and visual alarms indicate unsafe conditions
- alarm relay contacts available on terminals
- a fault relay and visual fault alarm
- flowmeter plus low flow fault indication and display
- alarm acknowledgement capability including audio defeat
- mA outputs for each target gas
- NEMA-12 packaging

NOTE: *All specifications stated in this manual may change without notice.*

1.1 Unpack

Unpack the **ISA-200 RAL(O)** and examine it for shipping damage. If such damage is observed, notify both **ENMET** customer service personnel and the commercial carrier involved immediately.

Regarding Damaged Shipments

NOTE: It is your responsibility to follow these instructions. If they are not followed, the carrier will not honor any claims for damage.

- This shipment was carefully inspected, verified and properly packaged at our company and delivered to the carrier in good condition.
- When it was picked up by the carrier at **ENMET**, it legally became your company's property.
- If your shipment arrives damaged:
 - Keep the items, packing material, and carton "As Is." Within 5 days of receipt, notify the carrier's local office and request immediate inspection of the carton and the contents.
 - After the inspection and after you have received written acknowledgment of the damage from the carrier, contact **ENMET** Customer Service for return authorization and further instructions. Have your Purchase Order and Sales Order numbers available.
- ENMET** either repairs or replaces damaged equipment and invoices the carrier to the extent of the liability coverage, usually \$100.00. Repair or replacement charges above that value are your company's responsibility.
- The shipping company may offer optional insurance coverage. **ENMET** only insures shipments with the shipping company when asked to do so in writing by our customer. If you need your shipments insured, please forward a written request to **ENMET** Customer Service.

Regarding Shortages

If there are any shortages or questions regarding this shipment, please notify **ENMET** Customer Service within 5 days of receipt at the following address:

ENMET Corporation
680 Fairfield Court
Ann Arbor, MI 48108
734-761-1270 734-761-3220 Fax

1.2 Check Order

Check the contents of the shipment against the purchase order. Verify that the **ISA-200 RAL(O)** is received as ordered. If there are accessories on the order, ascertain that they are present. Check the contents of calibration kits. Notify **ENMET** customer service personnel of any discrepancy immediately.

1.3 Serial Numbers

Each **ISA-200 RAL(O)** is serialized. These numbers are on tags on the equipment and are on record in an **ENMET** database.

2.0 Instrument Features



2.1 Exterior Features

The exterior of the instrument is shown in **Figure 1**. The exterior features are as follows:

Feature	Description
Enclosure	A NEMA-12 plastic box, approximately 10x8x6, with a clear hinged front cover.
Sample Air Hose	A six foot long hose to conduct a sample of the air from the source to the instrument. See Figure 1A .
Sample Port	The fitting for the sample air hose.
Sample/Calibration Valve	A red handled ball valve which directs the air from either the sample or the calibrate port. The handle points at the port, sample or calibrate, which is providing the air to the instrument
Calibration Port	The entrance for the calibration gas. The quick release fitting mates with one on the calibration adapter.
Front Cover Latch	A quick-release latch that holds the clear front cover in place, and is capable of being padlocked if desired.
Humidifier Tube	Located under a black sheet metal cover. Is a tube that extracts moisture from the atmosphere and adds it to dry sample air, before it is presented to the carbon monoxide and oxygen sensors.
Line Cord	A cord to supply 110 VAC to the equipment. Not illustrated.
Audio Alarm	A loud horn activated by certain alarm conditions.
Mounting Flanges	Flanges with holes for mounting the enclosure to a vertical surface.
Regulator	To connect to the compressed air line. Regulator output to the ISA-200 RAL(O) should be set to 55 PSI. See Figure 1A .

2.2 Display Panel Features

The display panel, shown in **Figure 1**, is viewed through the clear front cover of the enclosure, and is accessed by opening the cover. Features are as follows:

Feature	Description
Display	A 2 line, 16 character per line, LCD with backlight. The numerical values of gas concentrations, and other information are displayed.
Flowmeter	A flow indicator located at the output of the sample flow stream, which indicates quantitatively the flow of sample air or calibration gas through the instrument.
Visual Alarms	On both sides of the display, a red LED for each sensor on the instrument. Near the center of the panel, a green power LED and a red fault LED,
Pushbutton Switches	There are three of these, located near the center of the panel; they are yellow rectangular membrane switches. They are:
Option Switch	The top left switch. 
Select Switch	Directly to the right of the option switch. 
Alarm Acknowledge/ Audio Defeat Switch	Directly under the option switch. 

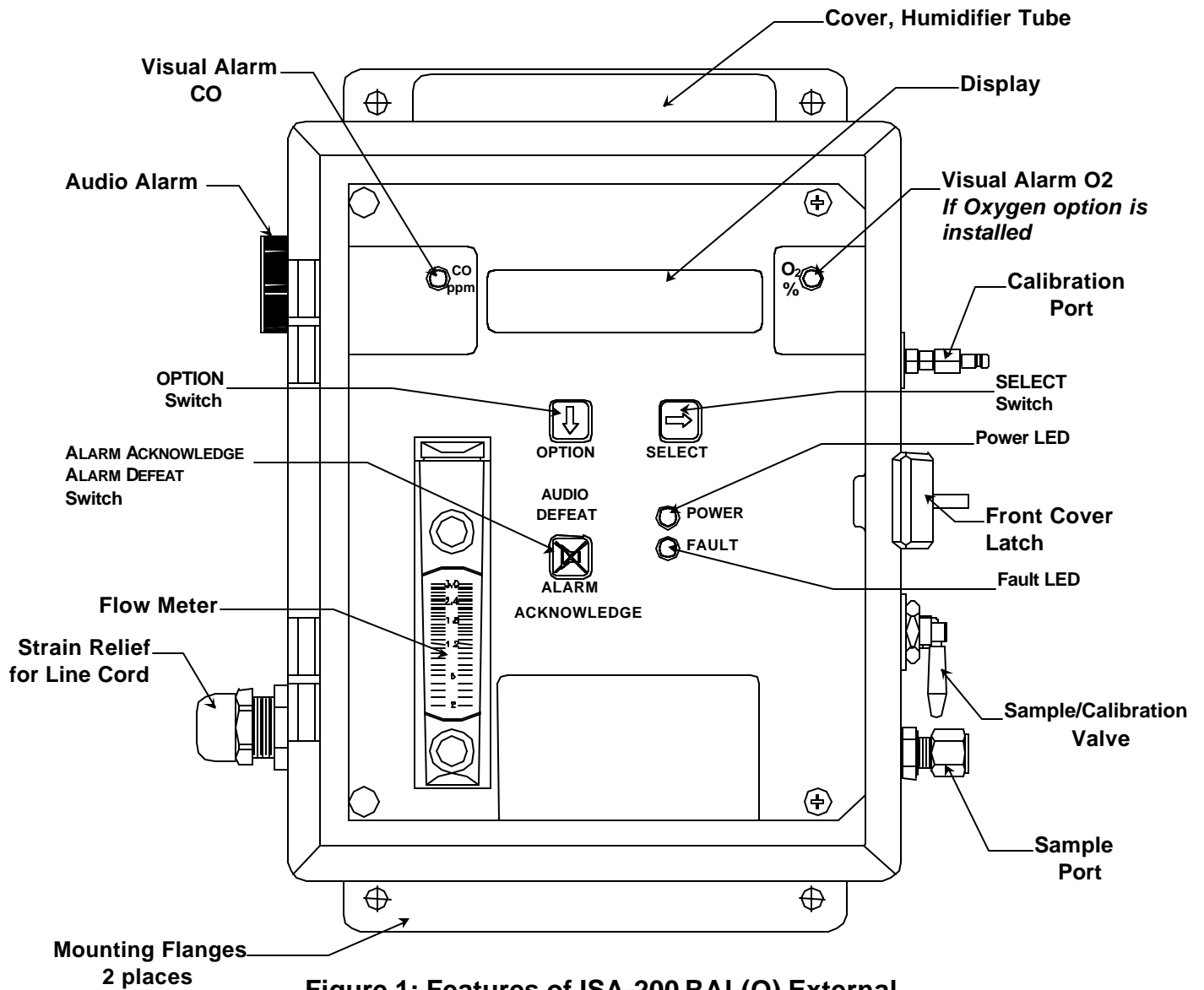

Figure 1: Features of ISA-200 RAL(O) External

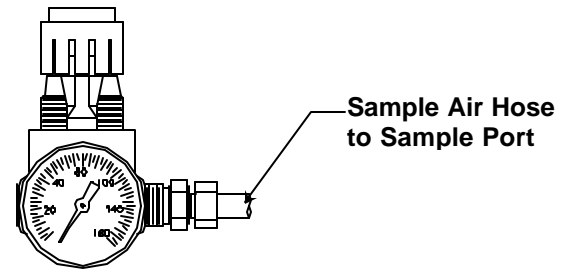

Figure 1A: Regulator

2.3 Circuit Board Features

The Display Panel is hinged on the right and is released by unscrewing the 2 thumb screws located in the left corners. After releasing the panel, it is swung to the right, exposing the interior of the enclosure. The Circuit Board is mounted on a plate at the back surface of the enclosure interior. Features are shown in **Figure 2**.

Feature	Description
Terminal Strip	This twenty-three position terminal is located at the bottom of the Circuit Board. On it are twelve positions for three contacts for each of four alarm relays, and three positions for the contacts of a fault relay. There are also two positions for each of the 4-20 mA outputs. (optional)
Manifold Housing	The sample manifold, the carbon monoxide and oxygen sensors are located under this small aluminum housing. Not illustrated in figure 2, see Figure 8 .

2.3 Power Supply

The power supply circuit is located on the bottom surface of the inside of the enclosure. The circuit is protected by two 1.0 Amp fuses mounted in fuse holders on the power supply board.

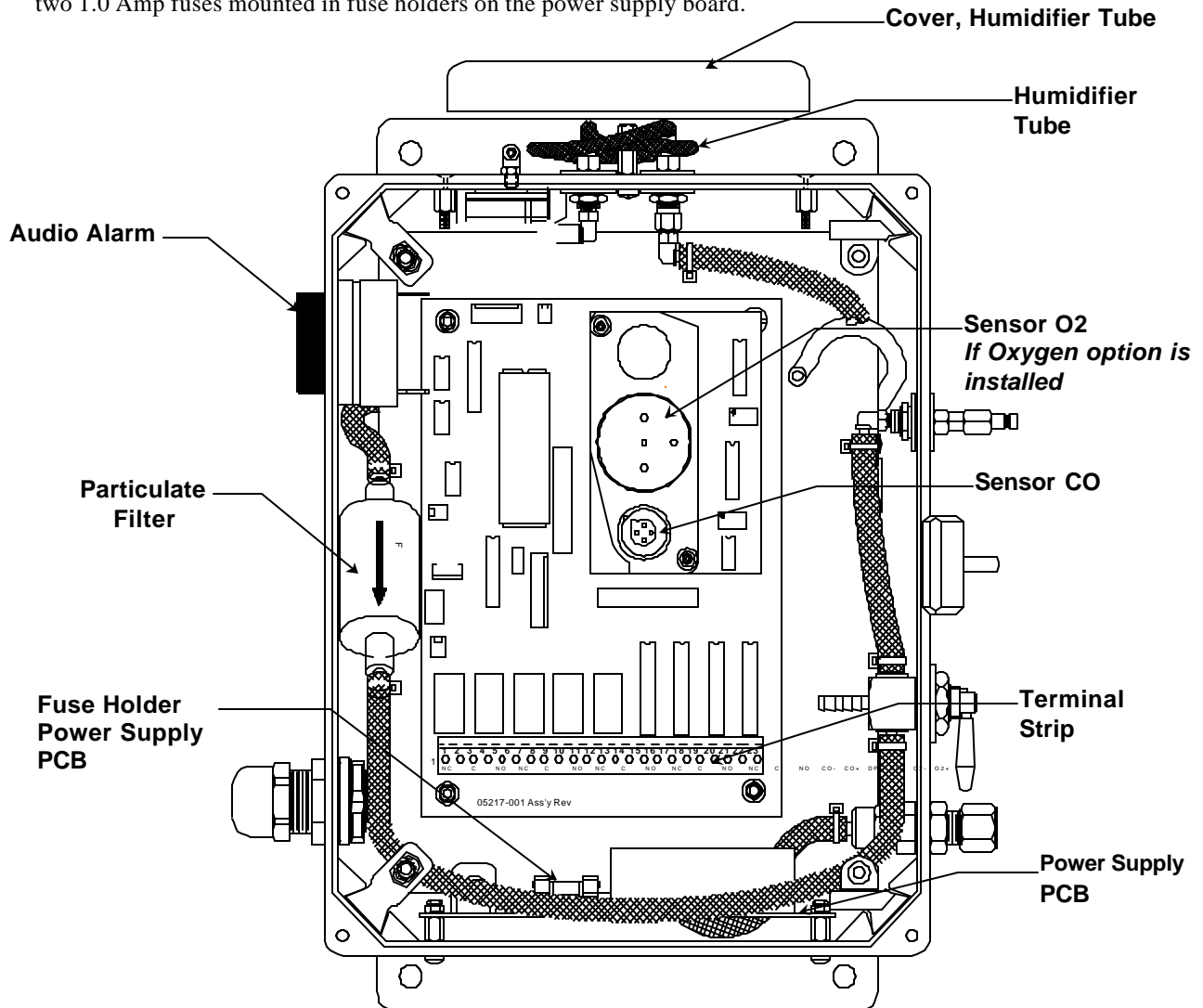

Figure 2: ISA-200 RAL(O) Interior Features

3.0 Installation

3.1 Mounting of Instrument

The **ISA-200 RAL(O)** should be located near the pipe or tank containing the air to be monitored, and upstream from where the air is being used. So that, the air sample enters the instrument before it reaches the users.

Upright (plumb and level) vertical orientation of the instrument is necessary for proper operation. Mount the instrument on an appropriate vertical surface using the mounting flanges provided. The holes in the flanges are 0.31 inch in diameter and form a 6 x 10.75 inch rectangle. **See Figure 3.**

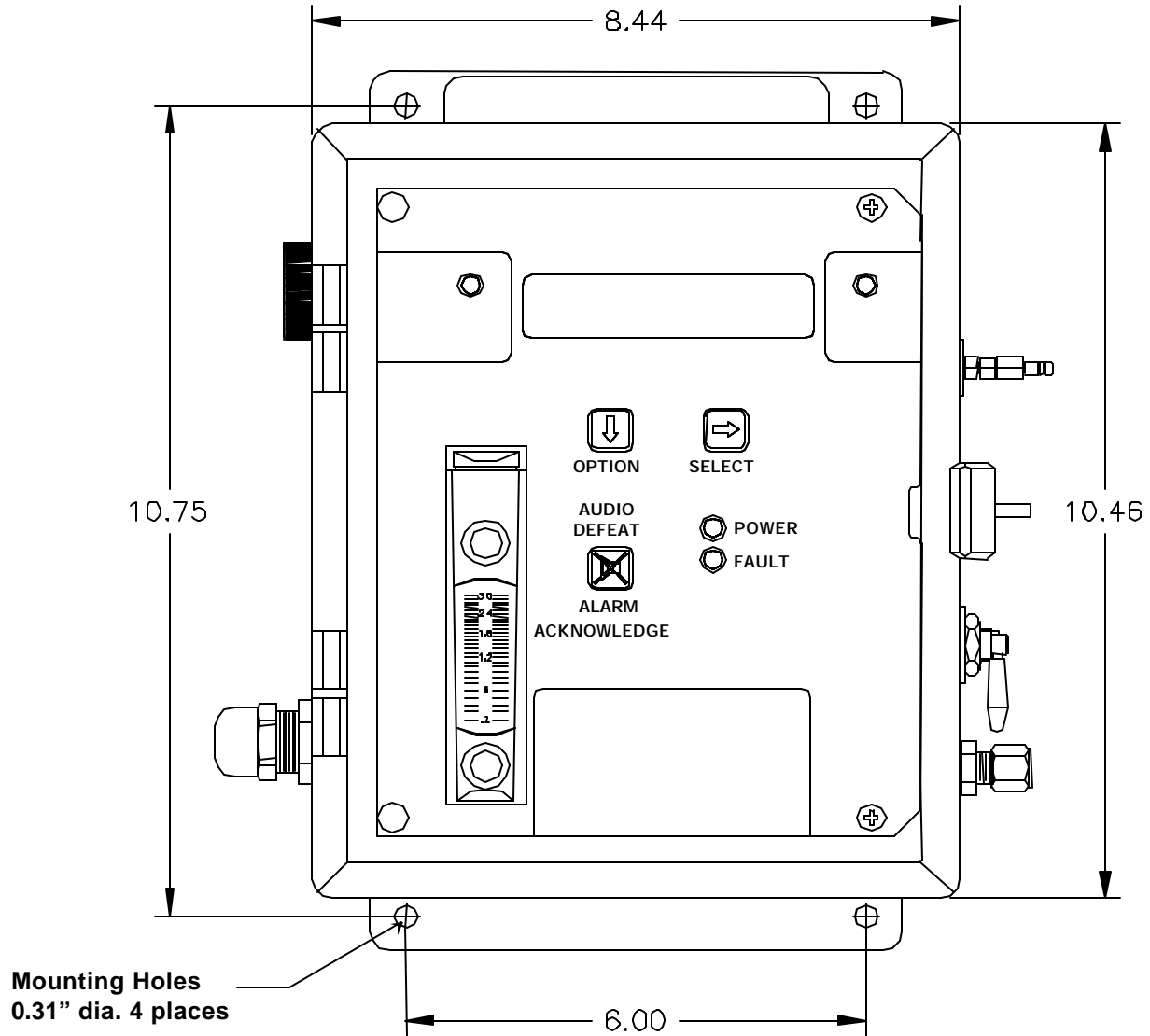

Figure 3: ISA-200 RAL(O) Mounting Dimensions

3.2 Sample Air Supply

Tap the pipe or tank containing the breathing air and use appropriate fittings to connect the sample input hose. The instrument is designed to operate from an air supply pressure of 50-55 psig; adjust the regulator and set the pressure at 55 psig. The flowmeter on the display panel indicates approximately 2 SCFH when the input pressure is 55 psig.

The sample air exits the instrument from two separated ports on the back surface of the enclosure. Take care not to obstruct these exit ports. After mounting the enclosure, they are not accessible.

Be sure that the red sample-calibrate valve handle on the right side of the enclosure is pointed down toward the sample input port.

3.3 Power Supply

Plug the line cord in a source of 110VAC power. The input power can vary from 100 to 240VAC, 50/60 Hz; if other than 110 VAC power is desired, the plug on the line cord must be changed.

Upon supplying air and power to the instrument:

- The green power on LED is lit.
- The display backlight is lit, and numbers are given on the display.

The instrument may go into alarm briefly, but the sensors stabilize quickly. If the instrument persists in alarm, acknowledge the alarm by pressing the ALARM ACKN/AUDIO DEFEAT switch. If alarm persists longer than 30 minutes, call **ENMET** customer service personnel.

3.4 Outputs

Two types of alarm outputs are available, relay contacts and optional 4-20mA outputs.

3.4.1 Relay Contacts

Relay contacts are available for each alarm; these are SPDT, rated at 2.0Amp at 110VAC, and may be latching or non-latching as required by the application. They are accessed on the terminal strip at the bottom of the circuit board see **Figure 2**. The positions given in Table 1:

Table 1: Relay Contacts

Position	Function	Contact
1	CO Alarm	NC
2	CO Alarm	C
3	CO Alarm	NO
4	O ₂ Alarm*	NC
5	O ₂ Alarm*	C
6	O ₂ Alarm*	NO
7	Not Used	
8	Not Used	
9	Not Used	
10	Not Used	
11	Not Used	
12	Not Used	

* This relay is activated by both the deficiency and abundance alarms.

These relay coils are energized when they are in the non-alarm state; the contact conditions given above are for the non-energized state, which is identical to the alarm state.

In addition, there is a fault relay, which changes state whenever the instrument is in a fault condition.

The contact positions are given in Table 2:

Table 2: Fault Relay Contacts

Position	Function	Contact
13	Fault	NC
14	Fault	C
15	Fault	NO

The coil of this relay is energized when the instrument is in the non-fault state; the contact conditions given above are for the non-energized state, which is identical to the fault state.

These relay contacts can be used to operate auxiliary alarms or other functions. Punch a hole at the bottom of the left side of the enclosure for a wire exit, and use appropriate cable and fittings to preserve the NEMA-12 rating of the enclosure.

3.4.2 Optional 4-20mA Outputs

Isolated 4-20 mA outputs are available for data logging or other purposes. An output is supplied for each sensor supplied in a particular instrument, and can be added when a sensor is added in the field. When all three sensors are supplied, these outputs are available on the terminal strip in the positions given in Table 3:

Table 3: Outputs for 4-20mA

Position	Channel	Function	Range
16	CO	Ground	4 mA = 0 ppm
17	CO	+ 4 to 20 mA	20 mA = 100 ppm
18	Not Used		
19	Not Used		
20	O2	Ground	4 mA = 0%
21	O2	+ 4 to 20 mA	20 mA = 25.5%

When both sensors are supplied, the sensor for CO output is on positions 16 and 17. The Oxygen output is on positions 20 and 21. Positions 18 & 19 are not used.

Wiring requirements are the same as for the relays.

3.5 Initial Calibration

If a calibration kit is available, calibrate the CO and O₂ channels of the instrument 24 hours after installation. See Section 5.0, Maintenance, for calibration instructions. After calibration, be sure to return the red sample-calibrate valve handle to the down position, pointing toward the sample input port.

4.0 Operation

4.1 Normal Operation Condition

With the **ISA-200 RAL(O)** installed as described in section 3, and in clean air, the POWER green LED is on, the display is lit, the flowmeter reads approximately 2 SCFH, and the information on the display is as shown in **Figure 4 Display**, for the sensor(s) installed in the **ISA-200 RAL(O)**. The red alarm and fault LEDs are not lit.

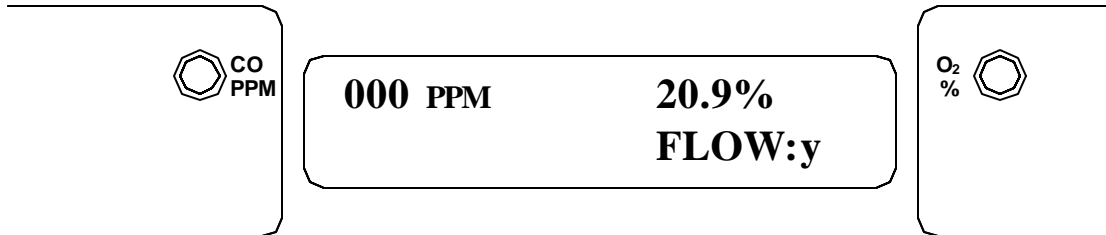

Example of display with O (Oxygen) option installed

Figure 4: ISA-200 RAL(O) Operational Display

4.2 Alarm Set Points

There is one alarm set point for CO, and two for oxygen. The factory settings of these alarm set points are as follows:

Table 4: Factory Alarm Set Points

Gas	Set Point
Carbon Monoxide	10 ppm
Oxygen Deficiency	19.5 % by volume
Oxygen Abundance	23.5 % by volume

These alarm set points can be changed within limits; see the maintenance portion of this manual for the procedure.

If the CO concentration increases above that of the alarm set point, the associated red LED is lit, the associated relay changes state, and the audio alarm is activated.

If the oxygen content of the sample air decreases below the deficiency alarm set point, the associated red LED is lit, the associated relay changes state, and the audio alarm is activated.

If the oxygen content of the sample air exceeds that of the abundance alarm set point, the associated red LED is lit, the audio alarm is activated, and both the oxygen alarm relay and the oxygen high alarm relay change state. There is one alarm LED for both the deficiency and abundance alarms.

4.3 Alarm Latching

An instrument is shipped with the alarms in the non-latching mode. The alarms may be independently configured in the non-latching mode by use of the maintenance menu.

- **IN THE LATCHING MODE:** at the cessation of the condition which causes an alarm, the alarm indications do not cease, and the alarm relay contacts do not revert to the non-alarm state, until the **ALARM ACKN/AUDIO DEFEAT** switch is pressed. An alarm can also be acknowledged by pressing the switch during the alarm condition; then at the cessation of the alarm condition, alarm indications cease and alarm relays revert to the non-alarm state. After an alarm is acknowledged, alarms in the latching configuration are re-armed to latch at the next alarm condition.
- **IN THE NON-LATCHING MODE:** at the cessation of the condition which causes an alarm, the alarm indications automatically cease, and the alarm relay contacts revert to the non-alarm state.

4.4 Audio Defeat

With the alarms in the non-latching configuration, pressing the ALARM ACKN/AUDIO DEFEAT switch during an alarm silences the audio alarm.

With an alarm in the latching configuration, pressing the ALARM ACKN/AUDIO DEFEAT switch during an alarm silences the audio alarm and unlatches the associated relay(s).

4.5 Display

In clean air, the display is as shown in **Figure 4**, for the sensor(s) installed in the **ISA-200 RAL(O)**. This position of the display is termed the "**operational display**". As explained below, the display can be changed to furnish other information by using the **OPTION** and **SELECT** switches.

Concentrations of CO are given in PPM (parts per million parts of air). Oxygen concentration is given in per cent by volume. When sample flow is reduced below a limit, the display switches from "Flow: yes" to "Flow: no", or from "Flow: y" to "Flow: n".

4.6 Operational Menu

The operational menu allows the user to:

- View alarm set point concentration values
- View alarm latching configurations
- Enter the maintenance menu with the proper key.

The operational menu is accessed with the **OPTION** and **SELECT** switches. The operational menu flow chart is shown in **Figure 5**,

- The **OPTION** switch is indicated with a "**O**".
- The select switch is indicated with a "**S**".

If the instrument is left at any location in the operational or maintenance menus, other than the operational display, with no action taken for a period of 45 seconds, it returns to the operational display.

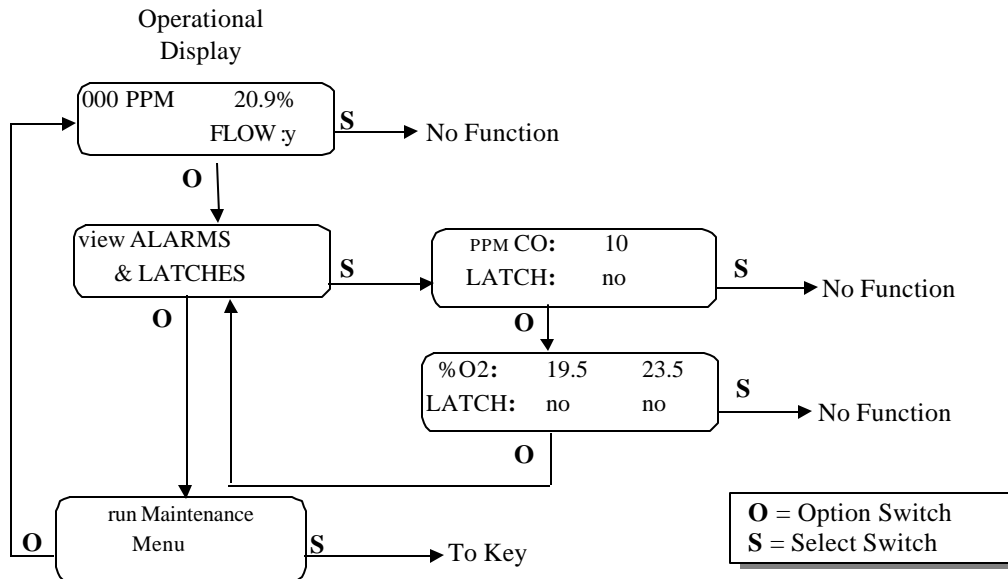

Figure 5: ISA-200 RAL(O) Operation Menu Flow Chart

4.7 Fault Indications

4.7.1 Low Flow Indication

A sensitive pressure switch is used to furnish a low flow indication. When the sample air pressure drops below approximately 30 psig, the fault light and audio alarm are activated, and the display reads either "Flow: no" or "Flow: n", depending upon the number of sensors installed in the instrument.

4.7.2 Other Fault Indications

Other fault indications are associated with sensor zero and calibration activities, and are described in the maintenance section 5.0 of this manual.

5.0 Maintenance

5.1 Maintenance Menu

The ISA-200 RAL(O) maintenance menu is accessed with the OPTION and SELECT switches. The maintenance menu diagram is shown in **Figure 6 Maintenance Menu Flow Chart**. From the operational display, press the OPTION switch twice; "run MAINTENANCE MODE" is displayed.

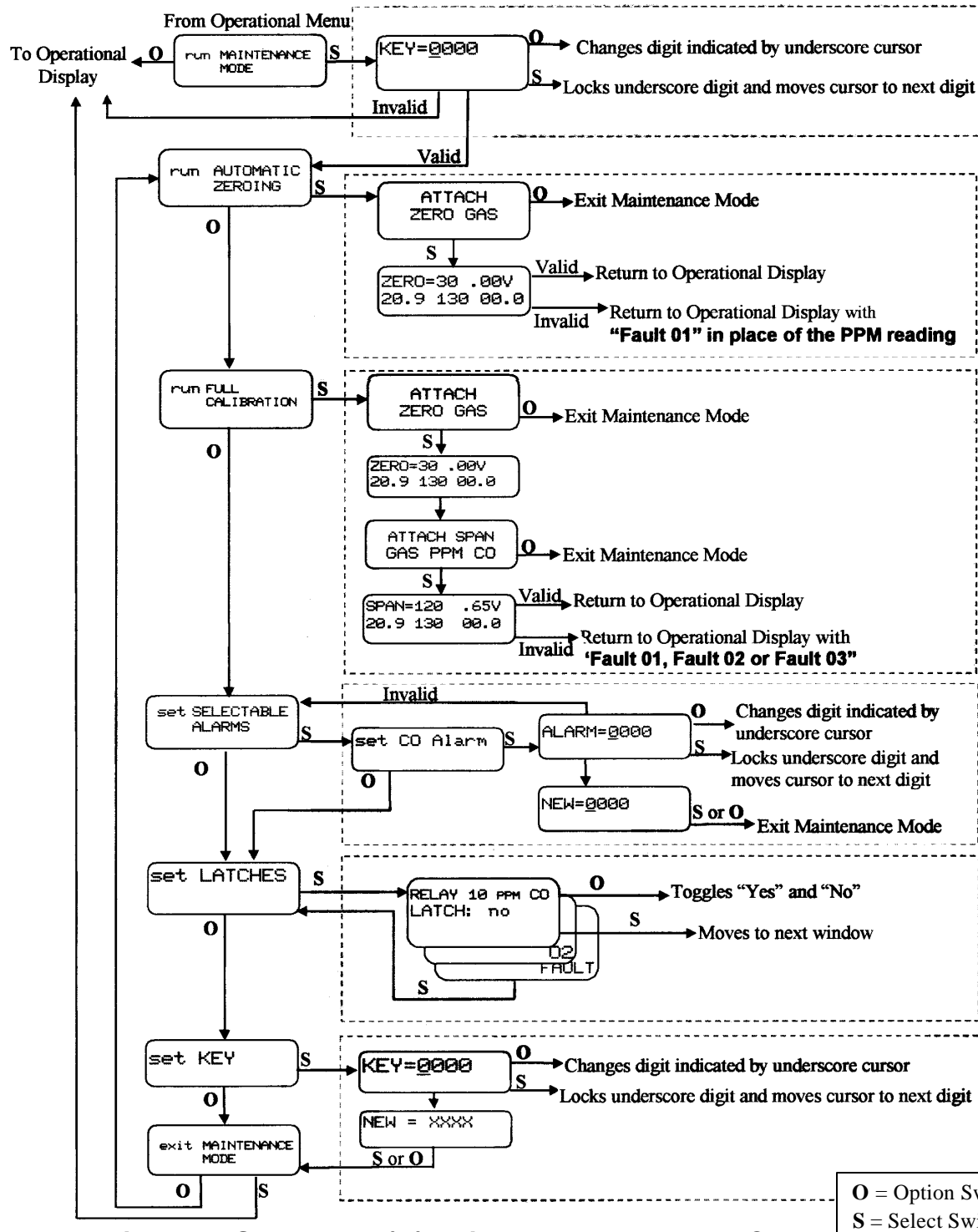

Figure 6: ISA-200 RAL(O) Maintenance Menu Flow Chart.

5.1.1 Key

Entrance to the maintenance menu is guarded with a four-digit key. The factory default setting of the key is 1270. When a valid numerical key is inserted, the user is allowed to enter the maintenance menu.

In the "run MAINTENANCE MODE" position

- Press the SELECT switch; "KEY = 0000" is displayed.
- In the "KEY = 0000" position, the underline cursor is under the left digit.
- Press the OPTION switch to change the left digit; select the correct digit.
- Press the SELECT switch, which locks the correct digit in place and moves the cursor one digit to the right.

Continue this process until the four-digit key is complete. When a valid key is inserted in this manner, the display is transferred to the "run AUTOMATIC ZEROING" portion of the menu. If an invalid key is inserted, "INVALID" is displayed briefly; then the **ISA-200 RAL(O)** returns to the operational display.

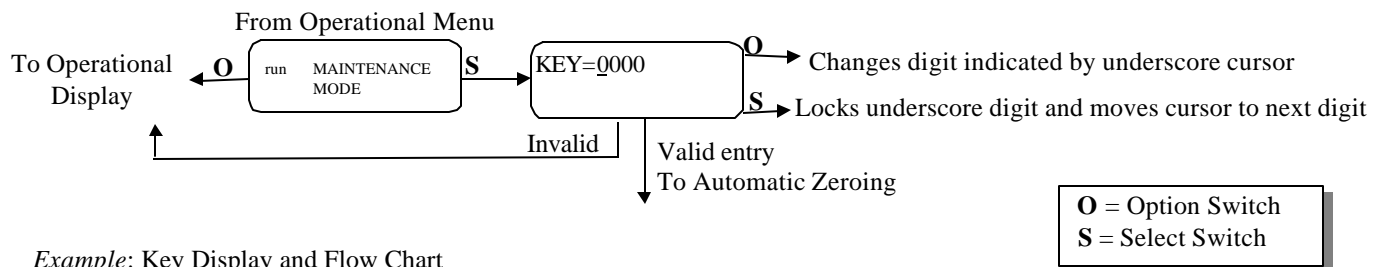
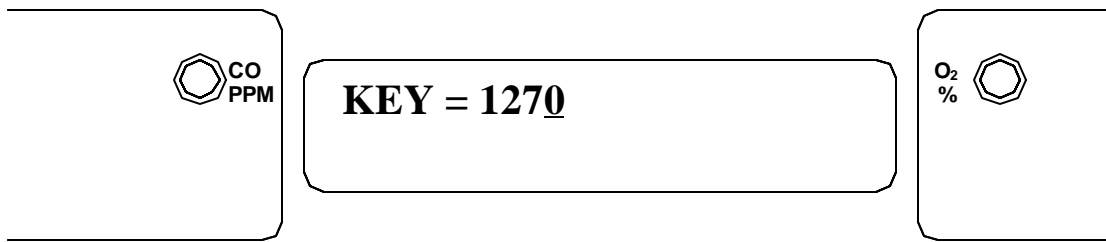

Example: Key Display and Flow Chart

5.1.2 Automatic Zeroing

A valid key entry sets the instrument in the "run AUTOMATIC ZEROING" position, which enables the setting of the zero gas concentration point. This is desirable if the zero reference of one of the sensors has drifted over time. For CO, the zero reference point is 0000 ppm CO; the zero reference point for oxygen is 20.9% oxygen by volume. Note that the calibration procedure described in section 5.1.3 also includes setting the zero point. If a full calibration is required, instead of setting just the zero point, press the OPTION switch once; "run FULL CALIBRATION" is displayed. See section 5.1.3.

TO SET THE ZERO POINT WITHOUT PERFORMING FULL CALIBRATION:

- From the "run AUTOMATIC ZEROING" position, see flow chart.
- Press the SELECT button; "ATTACH ZERO GAS" is displayed.

NOTE: While it is possible to zero the sensor(s) using a sample from a "clean" air line, this entails using the sample as a standard, and is best avoided. The best zero gas is a cylinder of 20.9% oxygen in nitrogen with no CO present. This is available in the calibration kit listed in section 6.0

Pressing the OPTION switch at this point aborts the procedure and transfers the display to the "exit MAINTENANCE MODE" position.

From Valid Key Entry

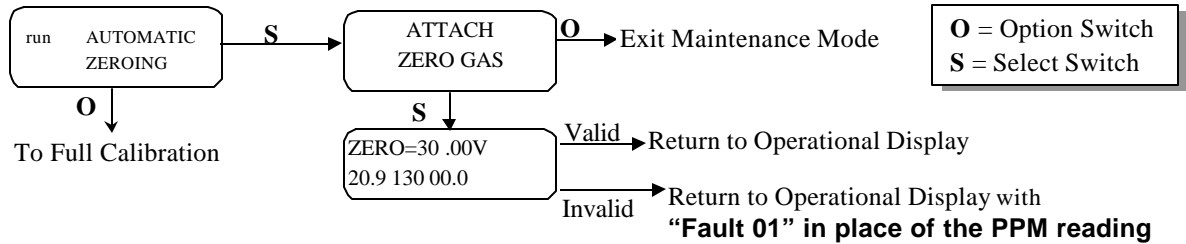

Example: Automatic Zeroing Flow Chart

TO CONTINUE THE PROCEDURE: attach a cylinder of zero gas to the Calibration Port using the calibration adapter, as shown in **Figure 7**. Open the cylinder valve, set the regulator at 55 psig, and turn the red handle of the sample-calibrate valve up toward the calibration port. Let the gas flow for about a minute

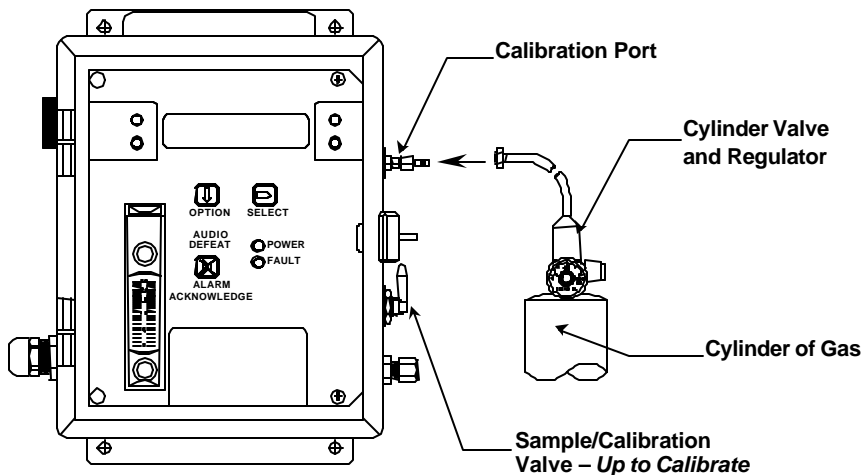

Figure 7: Connection of Calibration Gas Cylinder

- press the **SELECT** switch.
- "ZERO = 30 .00V" is displayed. This is a timer that counts down from 30 seconds, at the end of that time the procedure is finished. The instrument sets the clean air voltage point for the CO sensor and the 20.9% O₂ point for the oxygen sensor *if it is present*. It then examines the validity of these values; if they are valid, it goes back to the operational display. If a failure occurs, "Fault-01" is displayed in place of PPM reading in the operational display.

FAULT 01 indicates a clean air fault. Verify the proper zero gas is attached to the calibration Port and the sample-calibrate valve is up toward the calibration port. Repeat automatic zeroing procedure. If fault 01 still occurs, replace sensor in accordance with section 5.2.

After this procedure is complete, be sure to return the red handle of the Sample-Calibrate valve to the down position, pointing toward the Sample Port. If the Sample-Calibrate valve is not switched back to the sample port, the low flow fault indication is activated when the zero gas is removed.

5.1.3 Calibration

Insertion of a valid key results in the display: "run AUTOMATIC ZEROING". Press the **OPTION** switch once; "run FULL CALIBRATION" is displayed. Press the **SELECT** switch; "ATTACH ZERO GAS" is displayed; this is the start of the automatic zeroing procedure as described in paragraph 5.1.2, above. When this procedure is complete, "ATTACH SPAN GAS - SPAN = 20" is displayed to indicate that the correct span gas for this procedure is 20 ppm CO in a mixture of 20.9% oxygen in nitrogen. *Do Not Use Any Other Than The Correct Span Gas For This Procedure.*

Pressing the **OPTION** switch at this point aborts the procedure and sets the display at the "exit MAINTENANCE MODE" position.

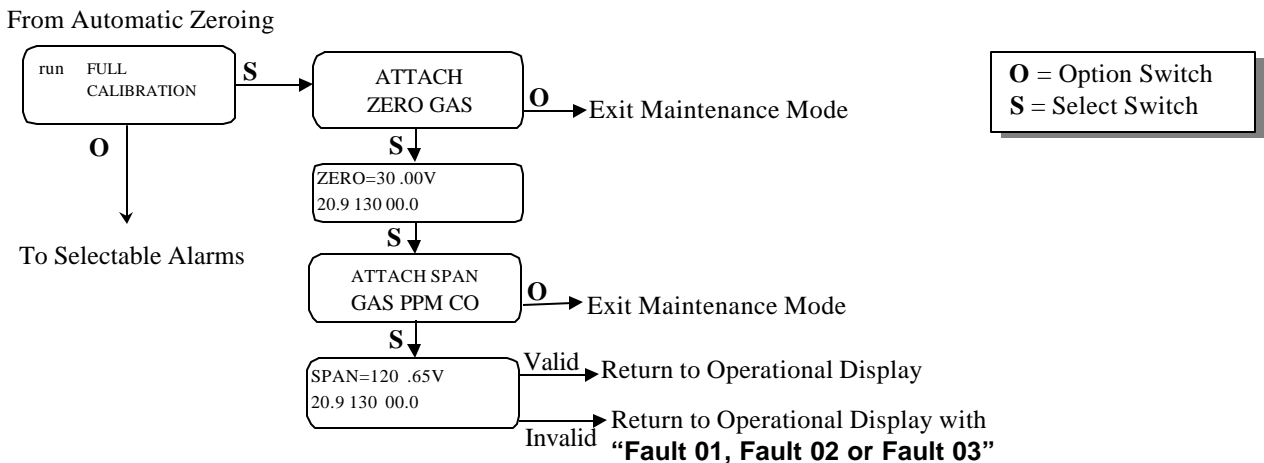

Example: Full Calibration Flow Chart

TO CONTINUE THE PROCEDURE:

- Attach the correct span gas to the Calibration Port with the calibration adapter turn the red handle of the Sample-Calibrate valve up toward the Calibration Port. See **Figure 7**.
- Open the cylinder valve, set the regulator at 55 psig.
- Allow the calibration gas to flow for **at least one minute**, then press the **SELECT** switch.

CAUTION: Pressure fluctuations may lead to aberrant oxygen readings if the **SELECT** switch is activated in less than one minute.

- "SPAN = 120 .00V" is displayed. This is a timer that counts down 120 seconds, at that point the procedure is complete. The ".00V" portion of the display reflects the sensor signal, as it responds to the CO gas. This value should increase.

After a valid zero and calibration, the instrument reverts to the operational display.

After an invalid zero or calibration one of the following will be displayed in place of the PPM reading in the operational display:

Table 5: Fault Alarm

Displayed	Cause	Possible remedy
• Fault 01	An invalid zero	<ul style="list-style-type: none"> • verify proper zero gas is attached to calibration port and sample-calibration valve handle is up • perform automatic zero • change sensor in accordance with section 5.2
• Fault 02	An invalid calibration	<ul style="list-style-type: none"> • verify proper calibration gas is attached to calibration port and sample-calibration valve handle is up • perform calibration • change sensor in accordance with section 5.2
• Fault 03	An invalid zero and calibration	<ul style="list-style-type: none"> • verify proper calibration gas is attached to calibration port and sample-calibration valve handle is up • perform calibration • change sensor in accordance with section 5.2

After this procedure is complete, return the red handle of the Sample-Calibrate valve to the down position, pointing toward the Sample Port. If the Sample-Calibrate valve is not returned to the sample port, the low flow alarm is activated when the calibration gas is removed.

NOTE: During the zero and span process, the sensor singles must fall within a preset limit. If they do not, the fault codes above are generated. If a fault code 2 is generated with calibrating the CO sensor, and the span voltage is close to, but not greater than 0.38V, an adjustment may be capable of being made, to extend the life of the sensor. Follow the procedure for calibrating a sensor as outlined in section 5.2.

5.1.4 Select Alarm Set Points

- Factory alarm set points are discussed in paragraph 4.2. To change the alarm set points, after inserting a valid key,
- Press the OPTION switch twice; "set SELECTABLE ALARMS" is displayed.
- Press the SELECT switch; "ALARM = 0000" is displayed, with the underscore cursor under the left digit.
- Press the OPTION switch to change the left digit; select the correct digit.
- Press the SELECT switch to lock in the correct digit and move the cursor one digit to the right. When a valid new alarm is selected, the "NEW = XXXX" is displayed.
- Press the OPTION or the SELECT switch, and the display changes to the next sensor. After all sensors have been displayed, the display returns to the "set SELECTABLE ALARMS" position.

Valid alarm ranges are as follows:

- CO: 5 to 99 ppm
- The oxygen alarm set points are 19.5% for deficiency and 23.5% for abundance, and are not adjustable.

From Full Calibration

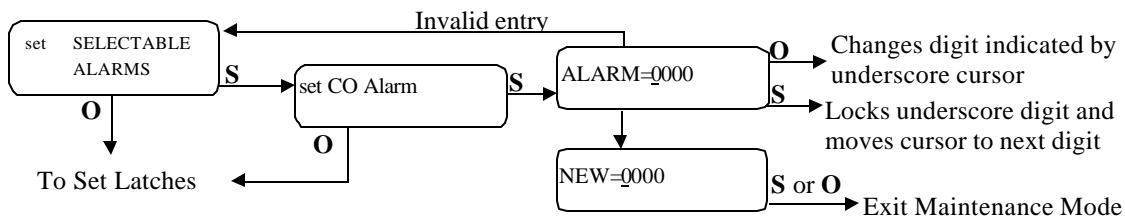

Example: Selectable Alarms Flow Chart

O = Option Switch
S = Select Switch

5.1.5 Set Latches

To latch and unlatch the alarm relays, after inserting a valid key, press the OPTION switch three times; "set LATCHES" is displayed.

- Press the Select switch; the particular alarm relay and its latch mode is displayed, for example, "RELAY: 10ppm CO, LATCH: no".
- Use the OPTION switch to toggle the latch mode between "yes" and "no". Select the desired mode. See section 4.3.
- Press the SELECT switch to step to the next relay. The procedure steps sequentially to all alarm relays in this manner; when complete, it returns to the "set LATCHES" position.

From Selectable Alarms

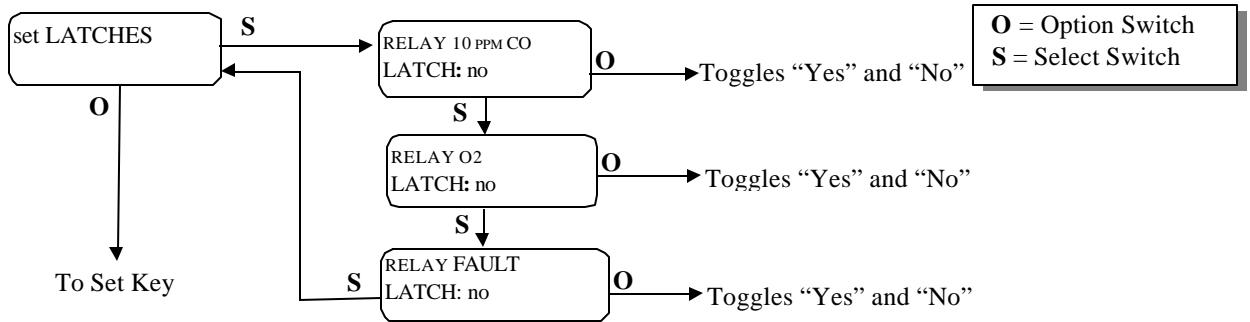

Example: Set Latches Flow Chart

5.1.6 Set the Key

To set a new key, after inserting a valid key, press the OPTION switch four times; "set KEY" is displayed. Press the SELECT switch; "KEY = 0000" is displayed, with the underscore cursor under the left digit. Use the OPTION switch to change the left digit, select the desired digit, and use the SELECT switch to lock the digit in place and move the cursor one digit to the right. When all four digits of the new key have been selected, "NEW = XXXX" is displayed. Record the new key; without it, the maintenance menu cannot be reentered once it is left. If the key is lost, call ENMET customer service personnel.

From the "NEW = XXXX" position, press either the OPTION or the SELECT switch; "exit MAINTENANCE MODE" is displayed.

From Set Latches

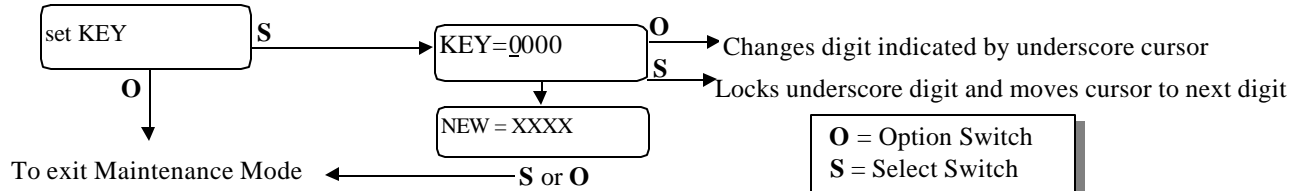

Example: Set Key Flow Chart

5.1.7 Exit

From the "exit MAINTENANCE MODE" position

Press the SELECT switch to resume the operational display.

Press the OPTION switch to reenter the maintenance menu at the "run AUTOMATIC ZEROING" position.

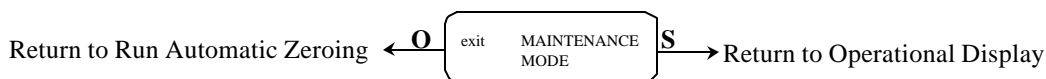

5.2 Sensor Replacement

5.2.1 CO Sensor

A CO sensor must be replaced when it can no longer be calibrated. To replace a sensor, perform the following steps.

- Turn off the electrical power. The sample air can continue to flow.
- Open the display panel and remove the two manifold retention screws and remove the manifold. See **Figure 9**.
- Remove the old CO sensor, which is the bottom most sensor, and replace it with a new sensor.

CAUTION: New sensors come with a shorting clip that must be removed for proper operation. See **Figure 8**.

- Replace the manifold. Observe that the flowmeter reading is correct.
- Turn on the electrical power.
- Wait 30 minutes, then recalibrate the sensor per the instructions in Section 5.1.3. As the timer is counting down during calibration, a voltage is displayed on the screen beside the timing count. This voltage must be between: .38V – .68V
- Adjust to: .65V if it is not between .38 – .68V. Adjust this voltage during the last 30 seconds of the calibration interval, using the bottom most potentiometer on the sensor circuit board. See **Figure 10**.
- Replace the manifold housing, and secure the display panel. An instrument without the manifold housing in place is susceptible to RFI.

5.2.2 Oxygen Sensor

An oxygen sensor must be replaced when it can no longer be calibrated in clean air. To replace the sensor, follow the general steps given for the replacement of the CO sensor, but effect a replacement of the oxygen sensor, which is the large sensor in the center position of the manifold. After sensor installation, wait four hours before recalibrating.

When recalibrating, it is not necessary to make a voltage adjustment.

5.3 Humidifier Tube

The humidifier tube is used to assure that the CO and oxygen sensors are not subjected to extremely dry air for a long period of time, which would decrease their useful life. Change the humidifier tube when changing a CO sensor at the completion of its useful life.

To change the humidifier tube:

- Remove the sheet metal cover from the top of the enclosure, exposing the humidifier tube. See **Figure 10**.
- Note the coiled arrangement of the tube. Remove the old tube and replace it with the new one.
- Replace the sheet metal cover.

5.4 Flow Control Orifice

A 0.006-inch diameter orifice is used to set the flow rate and to drop the air pressure. It is located where the air enters the humidifier tube, see **Figure 10**. In well-maintained medical air systems, this orifice should not clog. However, if difficulty is experienced in maintaining flow rate with assured inlet pressure, remove air pressure from the equipment and examine this orifice; replace it if necessary.

5.5 Particulate Filter Replacement

A filter is installed inside the enclosure, as shown in **Figure 10**.

To replace this filter:

- Obtain a new filter
- Note the correct direction of flow, as denoted by the arrow on the filter body
- Remove the old filter
- Replace with the new filter

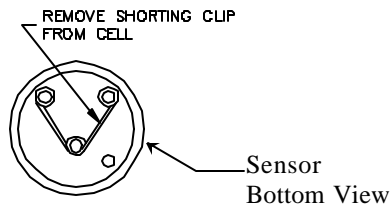

Figure 8: Remove Shorting Clip

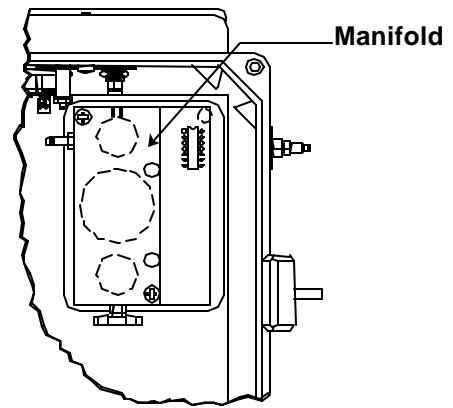

Figure 9: Manifold

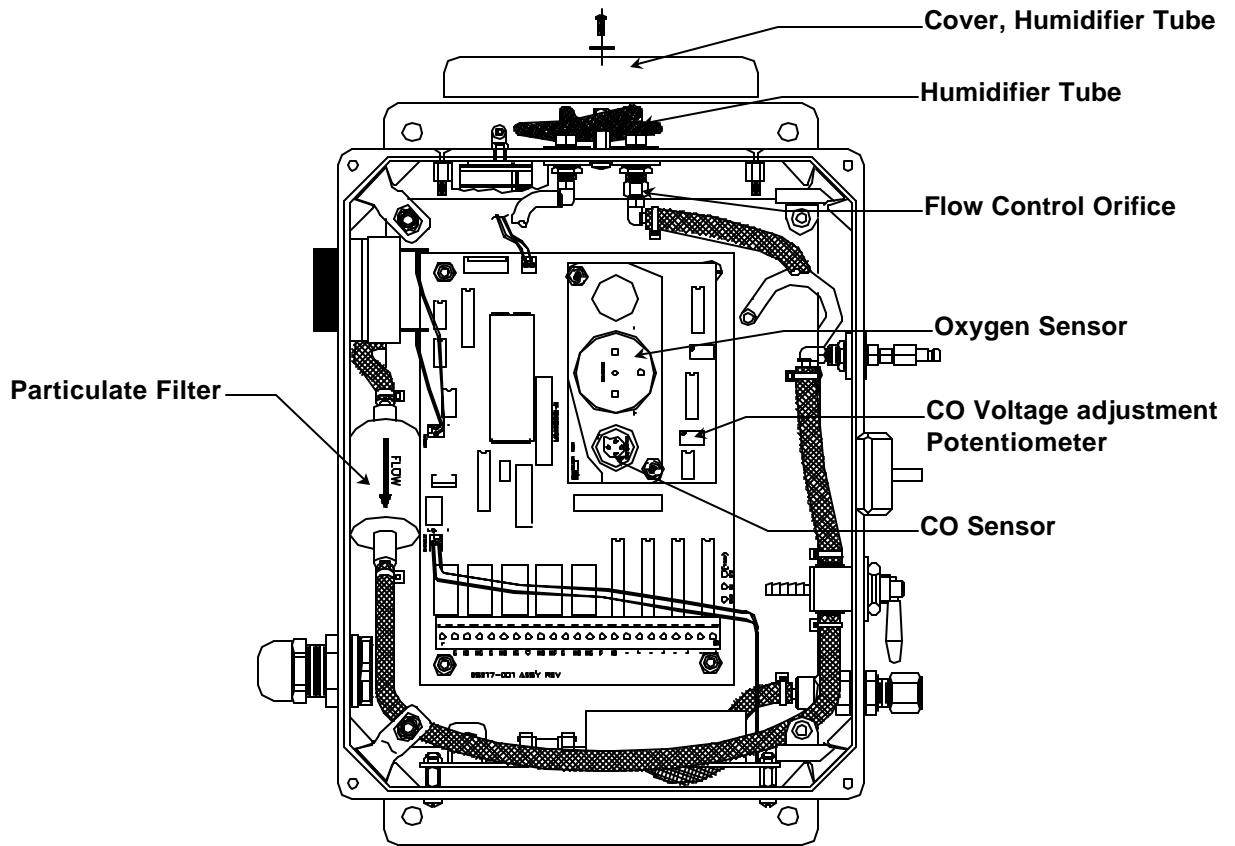

Figure 10: Location of Parts for Replacement

6.0 Replacement Part Numbers

ENMET part numbers for replacement parts:

Part number	Description
05221-001	Power Supply Circuit
64002-1000	Fuse, 1.0 Amp 5x20mm
67016-1106	Sensor, Oxygen
67016-1204	Sensor, CO
73070-009	Orifice
73108-002	Humidifier Tube
03401-000	Calibration Kit
03219-020	Gas Cylinder, 20 ppm CO in air
03296-209	Gas Cylinder, 20.9% oxygen in nitrogen
03700-022	Calibration Adapter
73089-002	Filter, particulate
05219-001	Sensor Board, <i>for units s/n 599 and below</i>
05217-001	Control Board, <i>for units s/n 599 and below</i>
05320-001	Control/Sensor Board, <i>for units s/n 600 and above</i>

7.0 WARRANTY

ENMET warrants new instruments to be free from defects in workmanship and material under normal use for a period of one year from date of shipment from **ENMET**. The warranty covers both parts and labor excluding instrument calibration and expendable parts such as calibration gas, filters, batteries, etc... Equipment believed to be defective should be returned to **ENMET** within the warranty period (transportation prepaid) for inspection. If the evaluation by **ENMET** confirms that the product is defective, it will be repaired or replaced at no charge, within the stated limitations, and returned prepaid to any location in the United States by the most economical means, e.g. Surface UPS/RPS. If an expedient means of transportation is requested during the warranty period, the customer is responsible for the difference between the most economical means and the expedient mode. **ENMET** shall not be liable for any loss or damage caused by the improper use of the product. The purchaser indemnifies and saves harmless the company with respect to any loss or damages that may arise through the use by the purchaser or others of this equipment.

This warranty is expressly given in lieu of all other warranties, either expressed or implied, including that of merchantability, and all other obligations or liabilities of **ENMET** which may arise in connection with this equipment. **ENMET** neither assumes nor authorizes any representative or other person to assume for it any obligation or liability other than that which is set forth herein.

NOTE: When returning an instrument to the factory for service:

Be sure to include paperwork.

A purchase order, return address and telephone number will assist in the expedient repair and return of your unit.

Include any specific instructions.

For warranty service, include date of purchase

If you require an estimate, please contact **ENMET** Corporation.

Appendix A

The Characteristics and Effects of Carbon Monoxide

Carbon monoxide is a colorless odorless toxic gas generated by incomplete combustion of a hydrocarbon fuel in air. It may be present where internal combustion engines, furnaces, boilers, and other combustion devices are present. It is toxic when inhaled because of its great affinity to hemoglobin, the oxygen carriers in the red cells of the blood. CO replaces the oxygen normally carried by the hemoglobin, and thus inhibits the delivery of oxygen throughout the body; the victim suffers from oxygen deficiency, and may die from asphyxiation. The symptoms and degree of danger resulting from exposure to CO depend upon the concentration of the gas and the length of exposure; this is shown in **Figure 8**. The **ISA-200 RAL(O)** instrument is employed to warn the user of the presence of CO, and to facilitate the assessment of the degree of danger that he or she is exposed to.

Based upon knowledge of the effects of CO, the Occupational Safety and Health Authority (OSHA) has set limits on exposure to CO in the workplace. These are 35 ppm (parts CO per million parts air) as an time weighted average for an eight hour day, and a maximum exposure of 200 ppm. For compressed air line applications, OSHA requires Grade D breathing air supplied, using a Compressed Gas Association (CGA) definition (G-7.1). Depending on interpretation of the OSHA respiratory standard, 10 ppm and 20 ppm CO have been used as maximum limits and standard instrument alarm points.

The **ISA-200 RAL(O)** has two preset alarm set points, at 10 ppm and 20 ppm CO, which are adjustable, but cannot be set below 5 ppm or above 100 ppm.

The curves below are for percent carboxyhemoglobin with 50% being the top curve, 5% the bottom. % COHb is a measure of the amount of hemoglobin occupied by CO rather than oxygen. CO effects upon children, adults engaging in physical activity, and smokers, are ore pronounced.

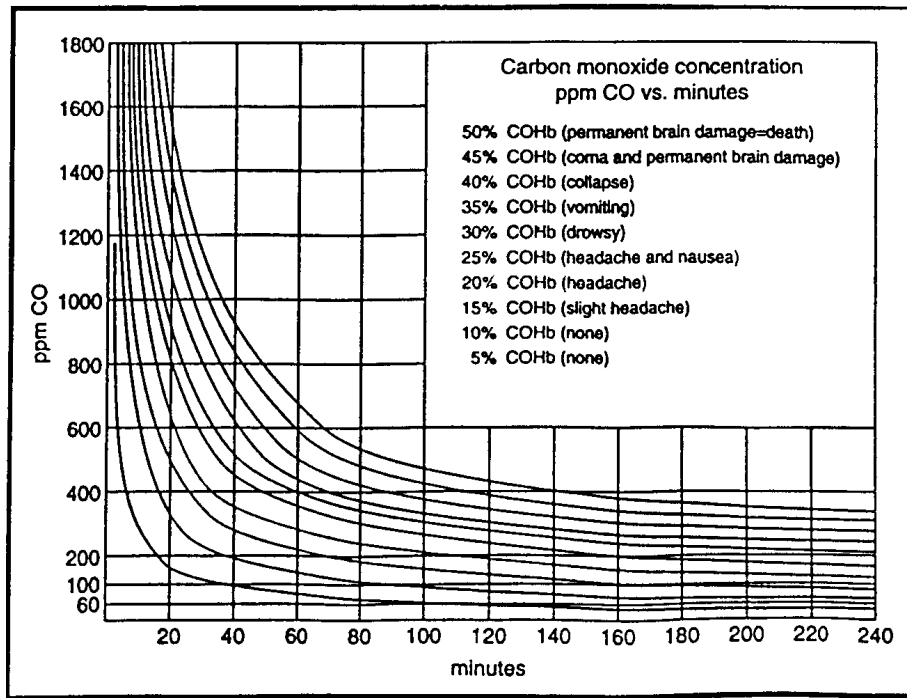

Figure 11: Carbon Monoxide Concentration